

# Instantaneous water heater CDX 11-U



Electronically controlled undersink instantaneous water heater in a compact size for hot water supply at a kitchen sink. The power consumption is controlled by the electronic in accordance with the ambient temperature and flow rate in order to obtain precisely the set outlet temperature and to keep it constant. The factory pre-set outlet temperature is 50 °C which can be mixed with cold water through the tap as accustomed.





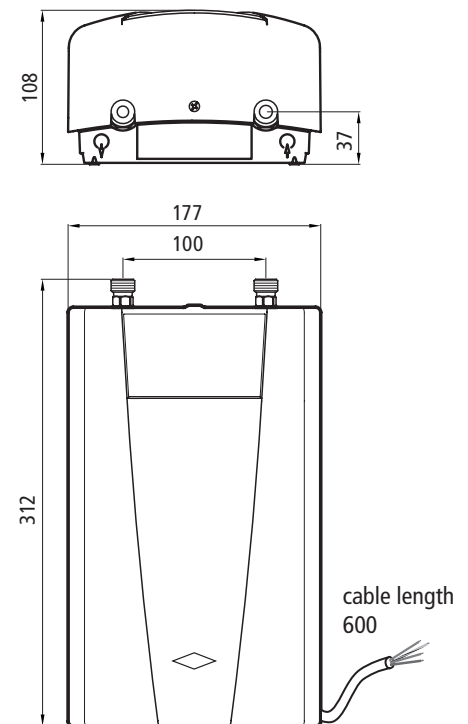

## Description

- Electronically controlled undersink instantaneous water heater for undersink installation.
- Power is automatically adjusted to the flow rate and the inlet temperature.
- Factory pre-set outlet temperature of 50 °C, internally adjustable.
- Easy installation under the kitchen sink due to small dimensions and outside 3/8" water connections for closed-outlet or open-outlet installation.
- For power cable for 3-phase power supply.

## Dimensions (in mm)



Type	CDX 11-U
Article No.	26113
Content; design (nominal pressure)	0.3 litres; closed-outlet <sup>1</sup> (10 bar / 1MPa)
Heating system	bare wire heating system IES®
Required specific water resistance	≥ 1000 Ωcm at 15 °C
Min. – max. flow rate	2.0 – 5.0 <sup>2</sup> l/min
Power rating at 3/PE 400 V 3~	11 kW
Rated current	16 A
Min. required cable size	1.5 mm <sup>2</sup>
Hot water flow rate <sup>M</sup> at Δt = 33 K (from 12 °C to 45 °C)	4.8 l/min
Outlet temperature	50 °C (internally adjustable 30 – 60 °C)
Maximum inlet temperature	30 °C
Weight filled with water	2.2 kg
Type of protection, safety mark	I / IP24    

<sup>1</sup> Appropriate for open-outlet installation

<sup>2</sup> Flow limited in order to obtain optimal temperature increase

<sup>M</sup> Mixed water

## Use

- kitchen sink
- wash basin

Installation is made directly at the connection pipes of the tap.

## Accessories

### LAB 2 (art. no. 82265)

Load shedding relay for combined connection of the water heater and the electric cooker (if no direct power connection is available)

## Sample text for specification

Delivery and installation of ... pcs. electronically controlled undersink instantaneous water heaters in compact size for economic hot water supply. Factory pre-set temperature is 50 °C. Type CDX 11-U, power rating 11 kW 3/PE 400 V, supply and installation, putting into operation.

CLAGE GmbH, Postfach 16 80, 21306 Lüneburg  
 Telefon 041 31 · 89 01-32, Telefax 041 31 · 83 200  
 E-Mail info@clage.de, Internet www.clage.de

# Instantaneous water heater CDX 11-U

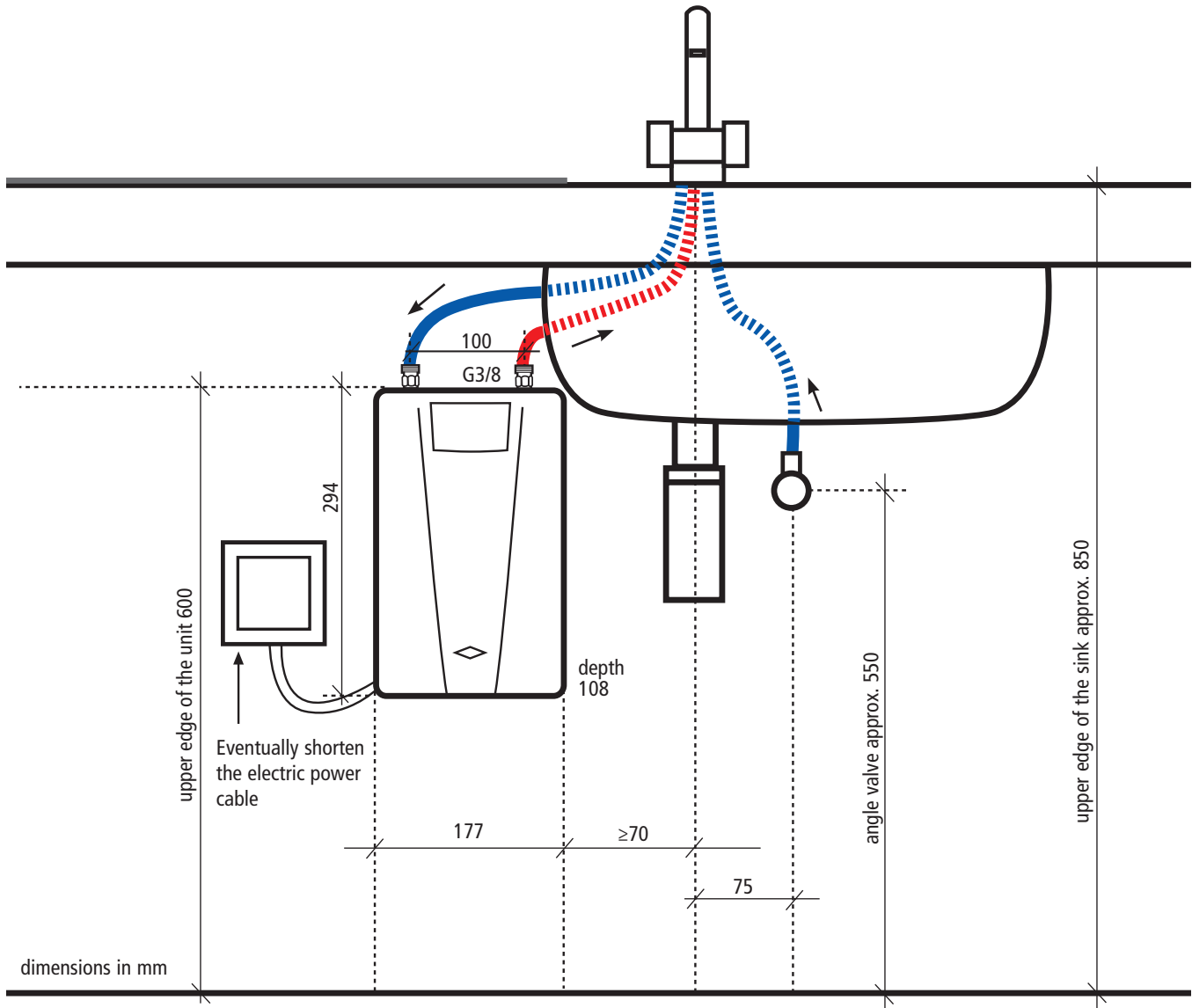

Example of an open-outlet installation with special tap.

Assembly and operating instructions are to be observed upon installation.

## alternative

Example of a closed-outlet installation

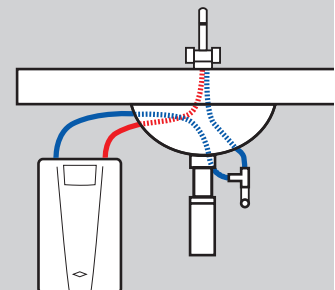

Installation with load shedding relay LAB (if no direct connection to electricity is possible).

