

**Gebrauchs- und Montageanleitung**  
***Operating and installation instructions***

Waschtischarmatur EWT

*Single lever basin mixer EWT*



de > 2

en > 2

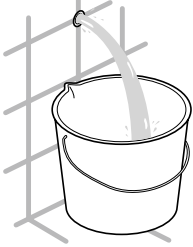
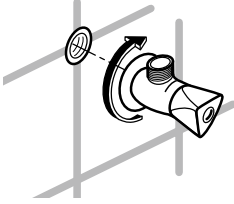
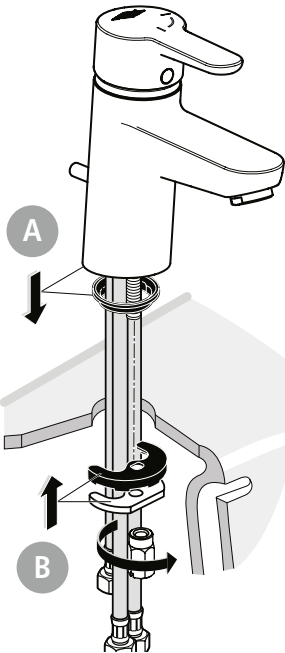

**1****2****3****5**

Druckminderer nur bei Warmwasserspeichern in die Kaltwasserleitung einsetzen! Nicht verwenden mit Durchlauferhitzern!  
 Insert pressure regulator in cold water connection with storage heaters only! Do not use with instantaneous water heaters!

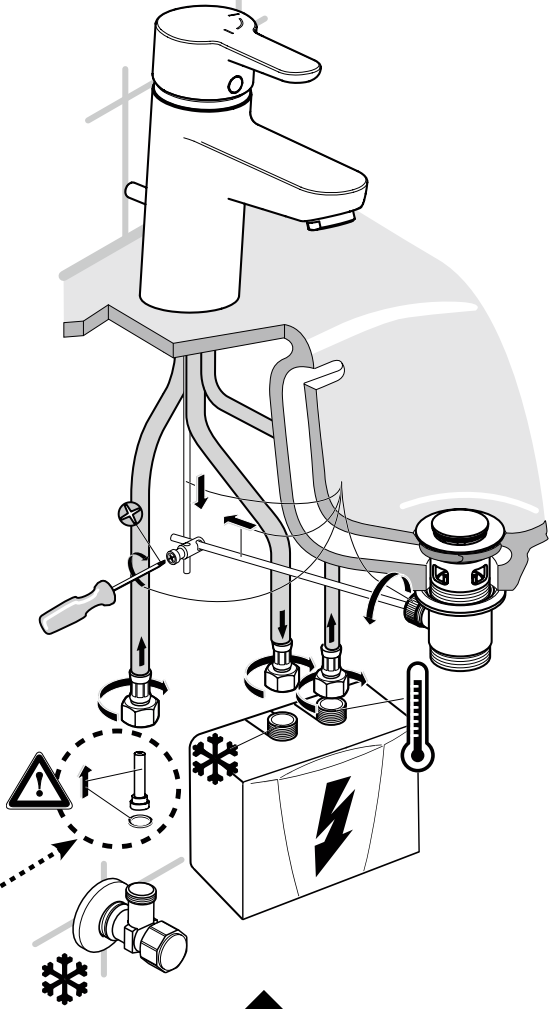
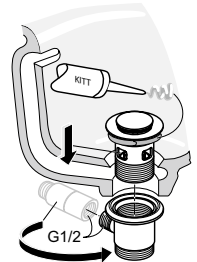
**4**

6

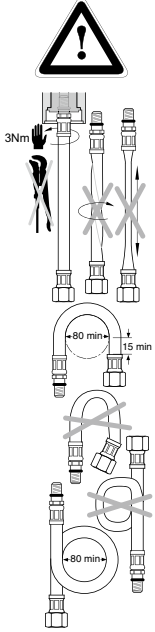

9

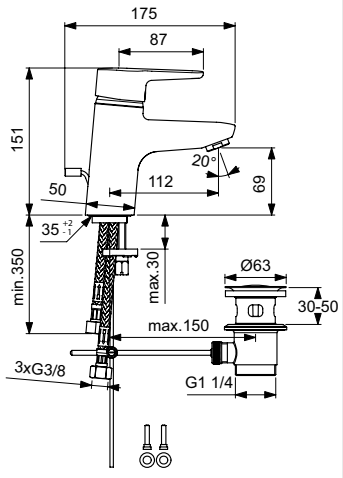
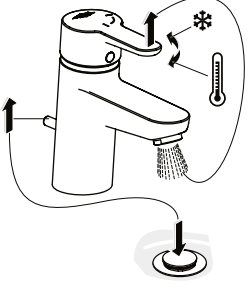
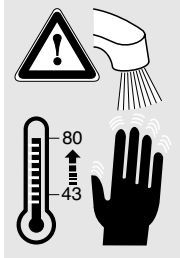

7

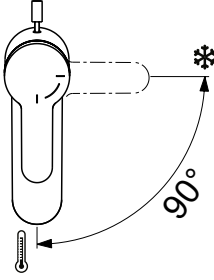

8

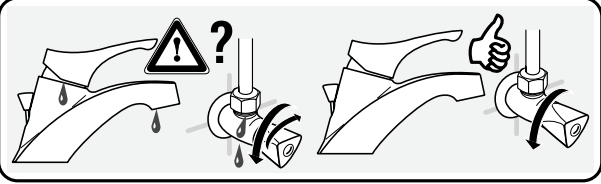

bar

°C

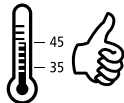
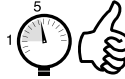
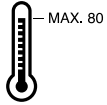

Q  
(3 bar)



l/min

6

## Reinigung und Pflege

- Kunststoffoberflächen und Sanitärarmaturen nur mit einem feuchten Tuch abwischen. Keine scheuernden, lösungsmittel- oder chlorhaltigen Reinigungsmittel verwenden.
- Für eine gute Wasserdarbietung sollten Sie die Entnahmearmaturen (Strahlregler und Handbrausen) regelmäßig abschrauben und reinigen. Lassen Sie alle drei Jahre die elektro- und wasserseitigen Bauteile durch einen anerkannten Fachhandwerksbetrieb überprüfen, um die einwandfreie Funktion und Betriebssicherheit jederzeit zu gewährleisten.

## Cleaning and maintenance

- Plastic surfaces and fittings should only be wiped with a damp cloth. Do not use abrasive or chlorine-based cleaning agents or solvents.
- For a good water supply, the outlet fittings (special tap aerators and shower heads) should be unscrewed and cleaned at regular intervals. Every three years, the electrical and plumbing components should be inspected by an authorised professional in order to ensure proper functioning and operational safety at all times.

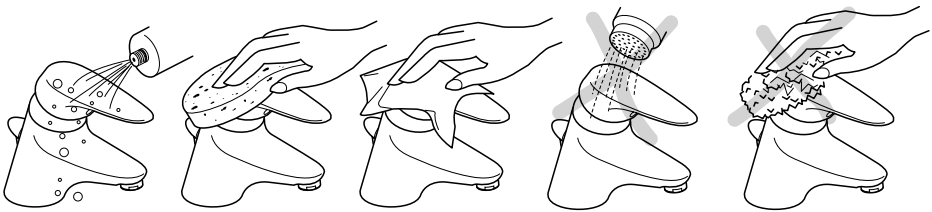

### CLAGE GmbH

Werkskundendienst

Pirolweg 1 – 5  
21337 Lüneburg  
Deutschland

Telefon: +49 4131 8901-40

Telefax: +49 4131 8901-41

E-Mail: [service@clage.de](mailto:service@clage.de)



4 010436 500001

Technische Änderungen, Änderungen der Ausführung und Irrtum vorbehalten.  
Subject to technical changes, design changes and errors. 9120-50000 06.15 B665290