

Application areas

Drinking water supply for:

- > Domestic kitchens
- > Public areas
- > Offices
- > Cafeterias / bistros
- > Restaurants / hotels







Water system

Zip HydroTap® G4 BCS

Product information



	boiling >  chilled + sparkling >  	G4 BCS 100/75	G4 BCS 160/175
Part number:		4100-44579	4100-44580
Number of users:		< 15	< 60
Water connection (thread connection):		G ½" or G ¾" *	G ½" or G ¾" *
Rated pressure [bar]:		2.5 – 7.0	
Boiling water temperature, adjustable [°C]:		68 – 100	68 – 100
Chilled water temperature [°C]:		5 – 10	5 – 10
Boiling water content [litres / cups ¹⁾]:		2.3 / 13	3 / 18
Chilled water capacity [glasses ²⁾ / h]:		75	175
Boiling water capacity [cups ¹⁾ / h]:		100	160
Reheating time [cups ¹⁾ / min]:		1.6	2.6
Standby power consumption [kWh / 24h]:		0.76 ³⁾	0.77 ³⁾
Nominal power at voltage 1~ / N / PE 230V AC [kW]:		2.15  with plug	2.3  with plug
Compact undersink unit [colour]:		white	
Protection class:		IP 20	
Weight (filled) [kg]:		28	37
Dimensions height × width × depth [cm]:		33.5 × 34,8 × 46.6	33.5 × 45.4 × 47.0

*) Connection hose G ½" with supplied adapter G ¾" 1) Standard cup with 167 ml 2) Standard glass with 200 ml 3) At 12 hours in standby mode

Description

- > Undersink water system, dispenses filtered boiling hot water and chilled still or sparkling drinking water for direct connection to the water supply
- > Touch display for menu navigation, for activating the energy saver modus and scalding protection as well as temperature setting of the water
- > Electronic temperature control
- > Easy-to-replace sub-micron particle filter cartridge with activated carbon filter, filters hazardous substances > 0.2 micron and improves the taste of water
- > Leakage protection system
- > Various electronic taps with safety function and button operation selectable

Note on carbonation function ^{N) SN)}

The CO₂ bottle for producing sparkling water is not included in the scope of supply. This is obtainable from retail outlets or specialist gas dealers. Pressure reducers are available for either SodaClub CO₂ bottles or standard commercial CO₂ bottles with W 21.8 × 1/14 RH thread.

Profitability comparison (Source: Internet comparison, 18.11.2018)

The comparison shows the total costs of the various systems including purchase, energy and maintenance costs over 5 years of use in Germany. Ideal for use in the office.

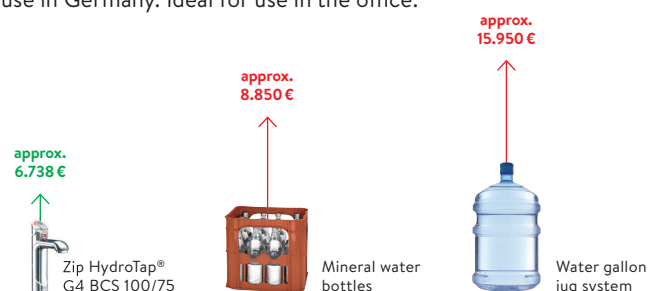

Calculation basis

Number of users:	15 persons
Number of days in use:	230 working days per year
Usage:	0.9 litres / person and day
Drinking water costs:	4 € per 1.000 litres
Mineral water bottles:	570 € per 1.000 litres
Water gallon jugs:	950 € per 1.000 litres

H) Note: the total quantity of sparkling water depends on the CO₂ bottle used. The carbon dioxide content is a maximum of 5 g per litre, corresponding to medium sparkling water.

SH) Safety note: It must be ensured that an uncontrolled escape of CO₂ gas cannot build up to a hazardous level. There must be a minimum room space of 6.8 square metres per 1 kg CO₂ with a ceiling height of 2.5 m.

Subject to technical changes and version changes. Errors and omissions excepted. Date of publication: 07.21

Product information 2 / 10

Water system

Zip HydroTap® G4 BCS

Installation



Daily user requirements and the available space in the cabinet below the selected special tap should be considered when selecting the appropriate model. The example below shows the installation with Zip HydroTap® G4 BCS 100/75.

Measurements in mm

Assembly and operating instructions must be observed upon installation.

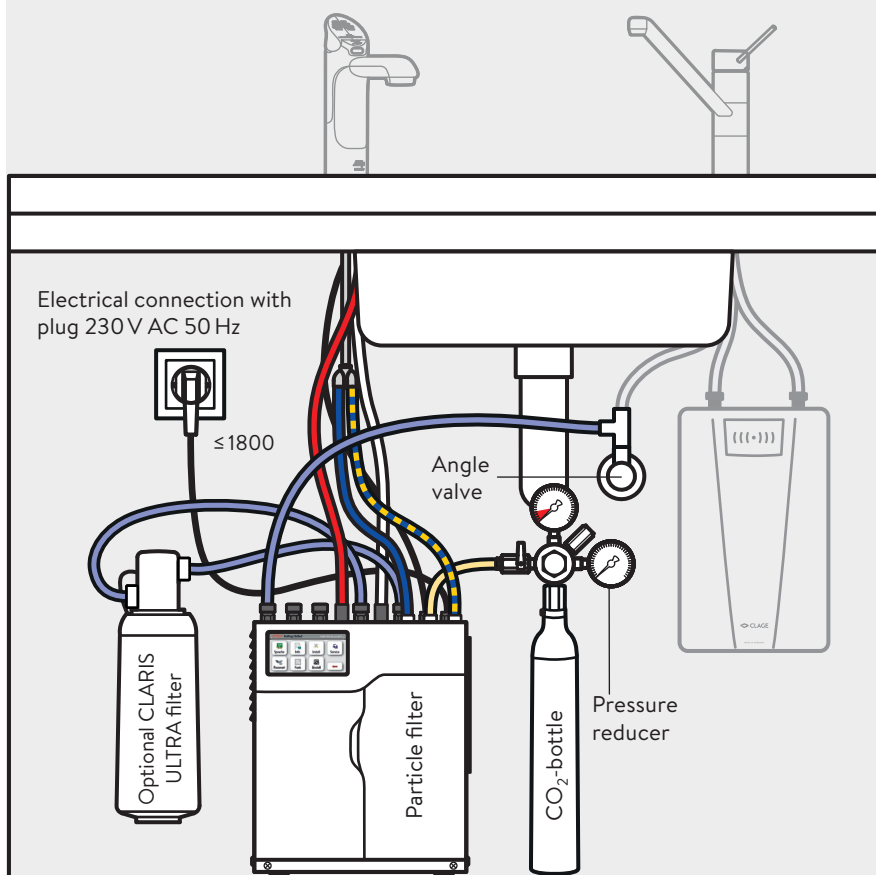

Unit dimensions:
(height × width × depth)

Zip HydroTap® G4 BCS 100/75
335 × 348 × 466 mm

Zip HydroTap® G4 BCS 160/175
335 × 454 × 470 mm

.....
Top clearance for undersink unit
(lower edge sink or drawers)
min. 200 mm

Right and left clearance for unit
min. 50 mm

Water system Zip HydroTap® G4 BCS Installation



Option 1: Tap "Classic BCS"

Measurements in mm

For the operation of the water system Zip HydroTap® G4 BCS you need a suitable tap, for example the tap "Classic BCS".

Assembly and operating instructions must be observed upon installation.

NEW!

Now also available as **Touch-Free** option with IR sensors for no-touch operation.

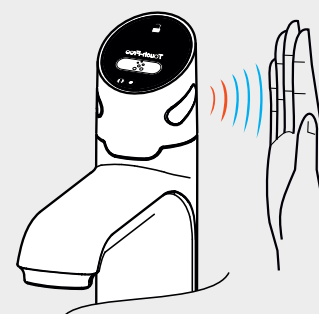

Drill hole diameter
for the tap

Ø 35.5
max. 50
min. 25

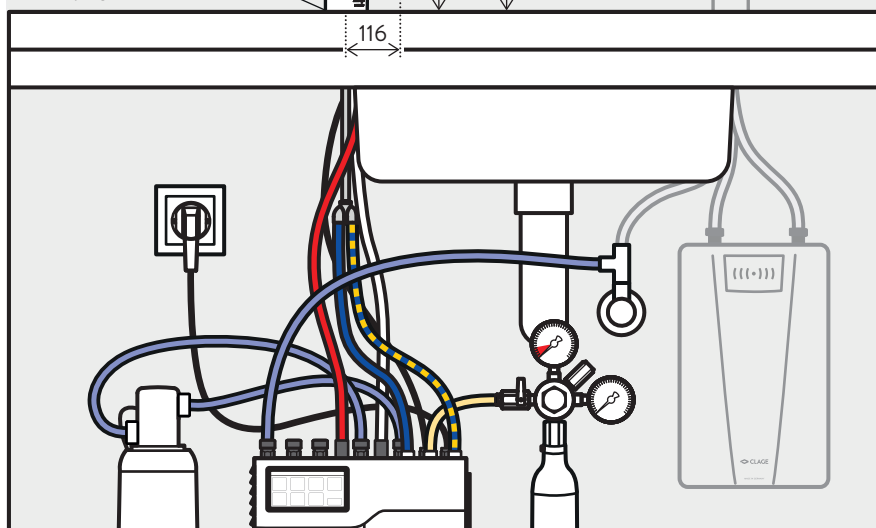
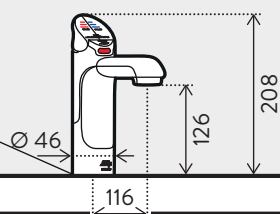

Installation at the kitchen sink



Installation as stand-alone unit with drainage front and extension KXTV.



Water system Zip HydroTap® G4 BCS Installation

Option 2: Tap "Arc BCS"

Measurements in mm

For the operation of the water system Zip HydroTap® G4 BCS you need a suitable tap, for example the tap "Arc BCS".

Assembly and operating instructions must be observed upon installation.

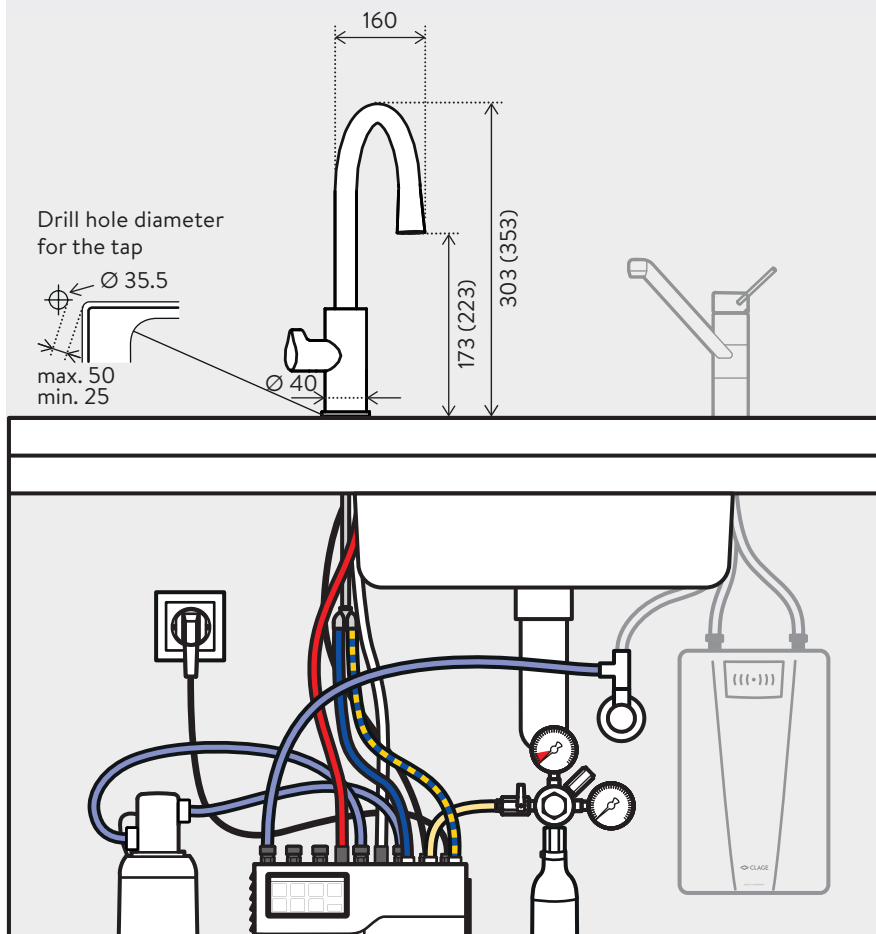

Flexible alignment

The Arc can be installed for left and right hand operation and the pipe outlet can be fixed at various angles and heights.

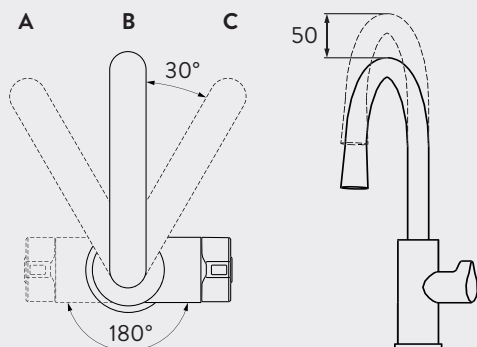

Installation as stand-alone unit with drainage front.



Water system

Zip HydroTap® G4 BCS

Installation

Option 3: Tap "Celsius Arc AIO All-In-One"

Measurements in mm

For the operation of the water system Zip HydroTap® G4 BCS you need a suitable tap, for example the tap "Celsius Arc AIO All-In-One".

Assembly and operating instructions must be observed upon installation.

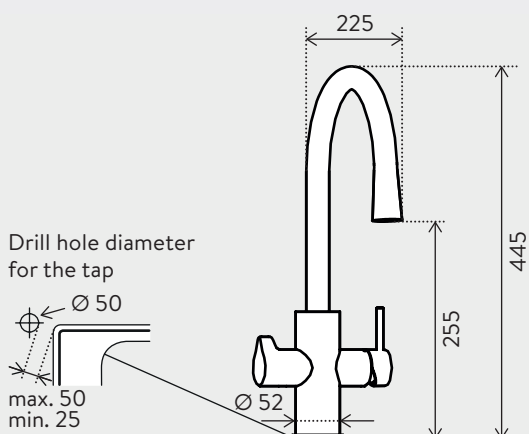

Note:

With this tap, both the water connections of the normal water supply (hot and cold water pipes) and the connections of the water system are connected to the tap.

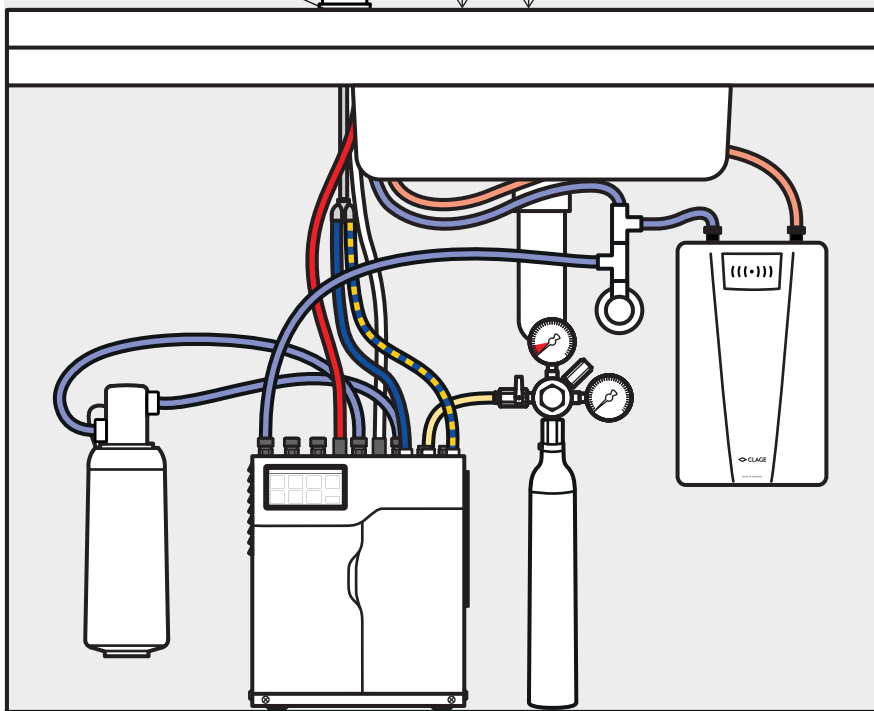



Zip Classic BCS

Electronic dispensing tap for Zip HydroTap® BCS with operating keys at the top, function indicator, holding function for easy canister filling, fixed spout 12 cm, height 21 cm, drill hole with 35 mm diameter required.

Classic BCS, polished chrome: Part no. 4100-44500
Classic BCS, brushed chrome: Part no. 4100-44501
Classic BCS, matte black: Part no. 4100-44502



Zip Arc BCS

Electronic dispensing tap for Zip HydroTap® BCS with operating lever on the side, function indicator, holding function for easy canister filling, fixed spout 16 cm, height 35.3 cm, drill hole with 35 mm diameter required.

Arc BCS, polished chrome: Part no. 4100-44503
Arc BCS, brushed chrome: Part no. 4100-44504
Arc BCS, matte black: Part no. 4100-44505



Zip Celsius Arc AIO "All-In-One"

Electronic all-round tap for Zip HydroTap® BCS with two tapping options: a side control button for tapping the types of drinking water provided by the undersink unit BCS (boiling, chilled, sparkling) and a single-lever mixer for tapping normal tap water from the central or decentralised hot water supply. With function indicator, holding function for convenient can filling, swivel spout 22 cm, height 44 cm, drill hole with 50 mm diameter required.

Celsius Arc AIO, polished chrome: Part no. 4100-44524
Celsius Arc AIO, brushed chrome: Part no. 4100-44525
Celsius Arc AIO, matte black: Part no. 4100-44526



Zip Touch-Free BCS

Electronic dispensing tap for Zip HydroTap® BCS with IR sensors and function indicator for hygienic, no-touch operation, fixed spout 12 cm, height 21 cm, drill hole with 35 mm diameter required.

Touch-Free BCS, polished chrome: Part no. 4100-44540

Water system

Zip HydroTap® G4 BCS

Accessories



KXF 2.1 (included)

Sub-micron particle filter cartridge filters contaminants > 0.2 microns and additionally improves the taste of the water.
For Zip HydroTap® G4 models from 02.2017.

KXF 2.1: Part no. 893702



KXV for Classic (optional)

The optional extension for raising the electronic dispensing tap Zip Classic by 13.5 cm.

KXV 10, polished chrome: Part no. 4100-44165

KXV 20, brushed chrome: Part no. 4100-44166

KXV 40, matte black: Part no. 4100-44167



KXTV for Classic (optional)

The optional stainless steel font with drainage connection and extension allows for flexible installation of the electronic dispensing tap at any location away from the sink.

KXTV 10, polished chrome: Part no. 4100-44565

KXTV 20, brushed chrome: Part no. 4100-44566

KXTV 40, matte black: Part no. 4100-44567



KXTV for Arc (optional)

The optional stainless steel font with drainage connection allows for flexible installation of the electronic dispensing tap at any location away from the sink.

KXTV 50, polished chrome: Part no. 4100-44560

KXTV 60, brushed chrome: Part no. 4100-44561

KXTV 70, matte black: Part no. 4100-44562



DMBCS

Pressure reducer with standard CO₂ connecting thread (1/2 inch), gas cylinders can be obtained via specialist gas suppliers

DMBCS: Part no. 4100-44120

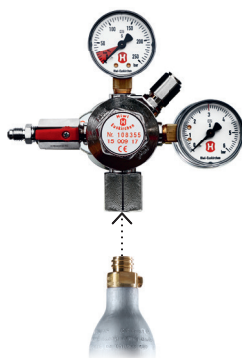

DMSP

Pressure reducer with Soda Club connecting thread.

DMSP: Part no. 4100-44125

COF (only available for dispatch within Germany)

CO₂ gas cylinder (charge 425 g) for Soda Club connecting thread.

COF: Part no. 9910-90005



Filter system CLARIS ULTRA for water softening (optional)

For hard, chalky water, the filter system CLARIS ULTRA is to be used (recommended from 10 °KH).

Filter head suitable for all CLARIS ULTRA-filter

Filter head Universal: Part no. 84519

Filter cartridge, capacity at 10 °KH 4.200 litre

CLARIS ULTRA 500: Part no. 84500

Filter cartridge, capacity at 10 °KH 8.500 litre

CLARIS ULTRA 1000: Part no. 84501

Filter cartridge, capacity at 10 °KH 20.000 litre

CLARIS ULTRA 2000: Part no. 84502



KXB (optional)

Plastic installation kit for G4 BCS160/175, allows for easier installation of ventilation in the base cabinet.

Dimensions (H × W × D): 4.0 × 49.5 × 50.0 cm.

KXB: Part no. 893450

Water system
Zip HydroTap® G4 BCS
Accessories



DTK (optional)

The digital temperature controller for Zip devices is used to keep the temperature in the cupboard below 35 °C when normal ventilation is not sufficient. The digital controller operates independently of the undersink unit and will require a separate 230 V socket.

DTK: Part no. 893159