

Boiling water heater KA



Application areas

Boiling water supply:





- > Offices
- > Canteens / Bistros
- > Restaurants / Hotels
- > Hospitals
- > Catering services



Boiling water heater KA

Product information



	boiling > 		
	 KA 15	 KA 25	KA 40
Part number [case painted white]:	4100-44015	4100-44025	4100-44040
Part number [case stainless steel]:	4100-44315	4100-44325	4100-44340
Water connection (thread connection):	G ½"		
Temperature range [°C]:	99 - 100		
Boiling water content [litres / cups ¹⁾]:	15 / 90	25 / 150	40 / 240
Capacity boiling water [litres / cups ¹⁾ / h]:	150	215	360
Reheating time [cups ¹⁾ / min]:	2.5	3.0	6.0
Reheating time with complete filling ²⁾ [min]:	43	50	64
Standby power consumption [kWh / 24h]:	2.8	3.1	3.3
Nominal power rating at 1~ / N / PE 230 V AC [kW]:	2.4	3.6	2 × 3.0
Power supply:	1~ / N / PE 230 V AC		
Functional indicator:	✓		
Protection class:	IP 20		
Dimensions height × width × depth [cm]:	60.0 × 39.0 × 30.0	78.0 × 39.0 × 30.0	84.0 × 51.5 × 28.5
Connecting cable:	 direct connection		
Weight (filled) [kg]:	34.5	47.0	71.0

1) Standard-cup with 167 ml 2) At 10 °C Cold water temperature

Description

- > Instant boiling water heater for continuous supply of boiling water in large quantities
- > Thermostatically controlled, twin-chamber technology with stainless steel boiling tank prevents the mixing of cold and hot water
- > Premium insulation and cool touch two way valve with safety lock
- > Dispensing valve for convenient filling of tea or coffee pots or single cups
- > No escaping steam – the steam is used internally to heat the incoming water
- > Two service openings for problem-free decalcification
- > Double safety thermal shutdown

Dispensing valve

The two-way safety dispensing valve has two positions:

1. Normal position:

for cup filling



The boiling water flows when the lever be pulled forwards.

The position of the lever determines the water flow. If the lever is released, the water stops immediately in this mode.

2. Locking position:

for convenient jug filling



To do this, turn the lever 180 degrees from the normal position.

The boiling water flows when the lever is pulled towards itself until it clicks into place. In this position, a vessel can be filled without having to hold the lever.

Boiling water heater KA Installation

The outlet of the automatic boiling water heater must be located above the sink or the drip tray. The bottom edge of the outlet should not be less than 200 mm above the drip tray. If larger vessels are to be filled, the distance must be increased.

Dimensions in mm

The example shows the installation of a KA15 as flush installation with visible collecting funnel. Alternatively, a surface installation with a pipe section is possible.

For maintenance work, a minimum clearance of 150 mm above, 120 mm left and 20 mm right must be observed.

Assembly and operating instructions must be observed upon installation.

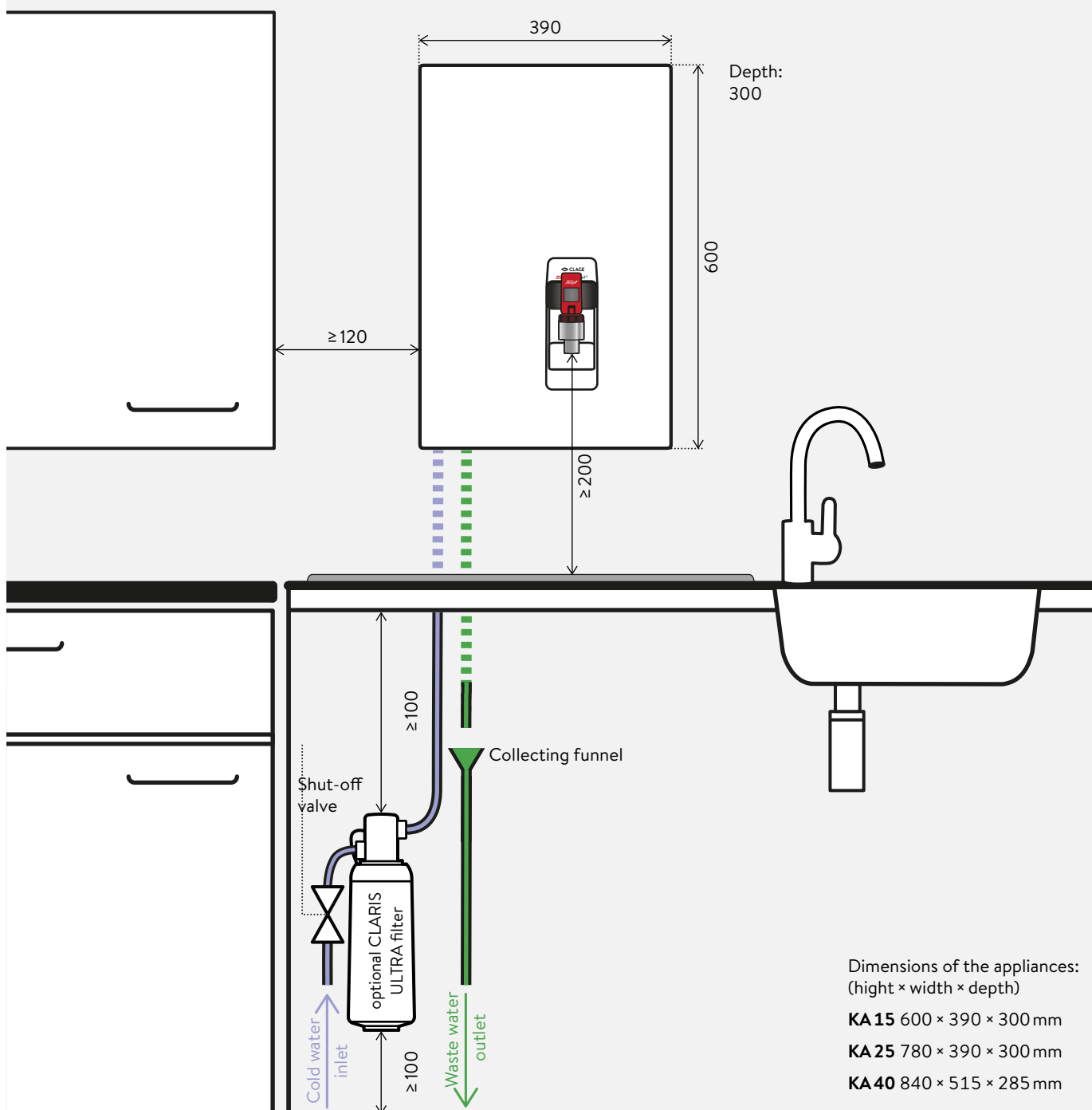

Boiling water heater KA Installation

The example shows the water connections when installing a KA15, as flush installation with visible collecting funnel.

Dimensions in mm

Assembly and operating instructions must be observed upon installation.

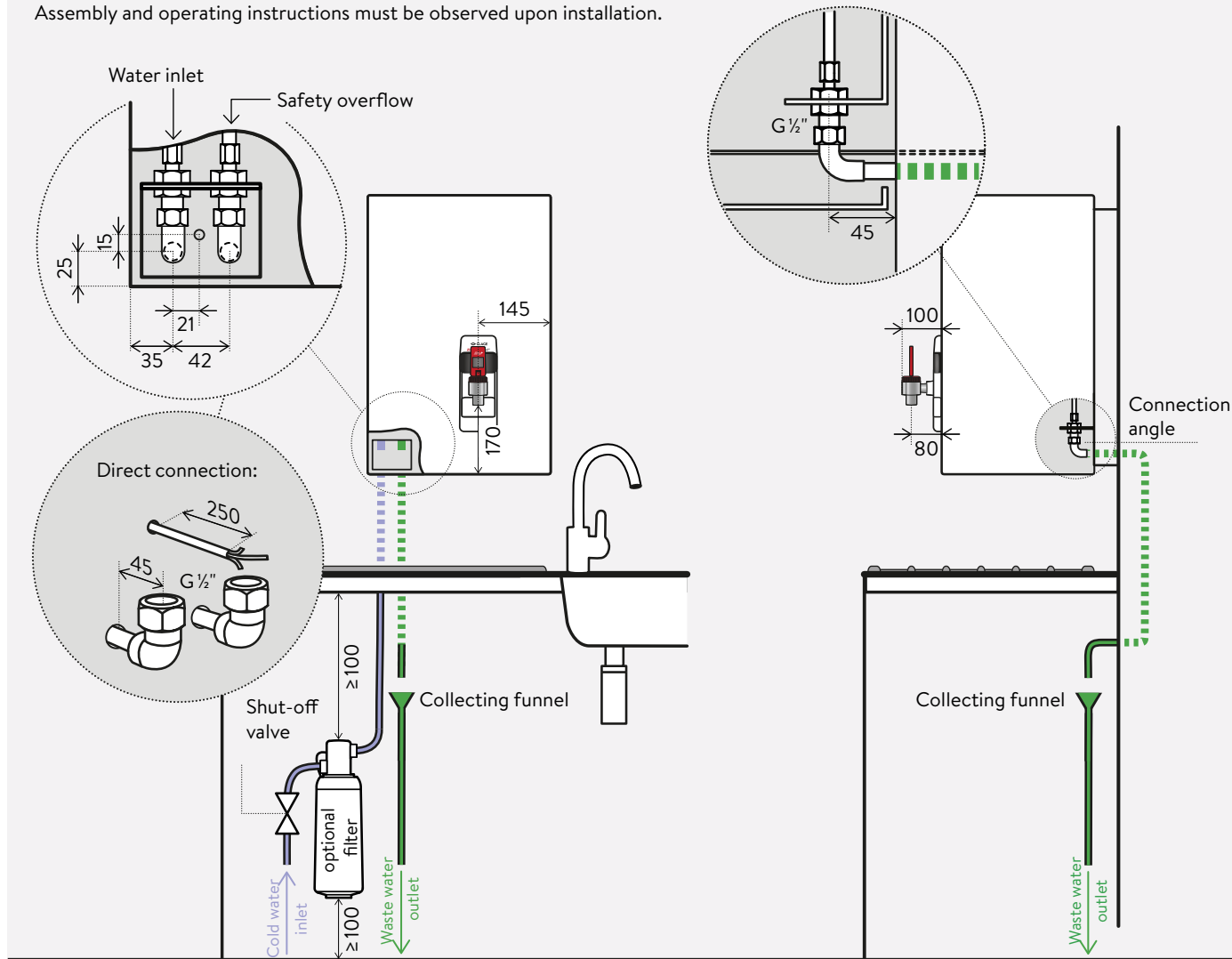

Flush installation with visible collecting funnel

In this case, a commercial funnel must be set for the overflow. The safety overflow must be lengthened by means of a pipe, its end visible outside the appliance leads in the funnel.

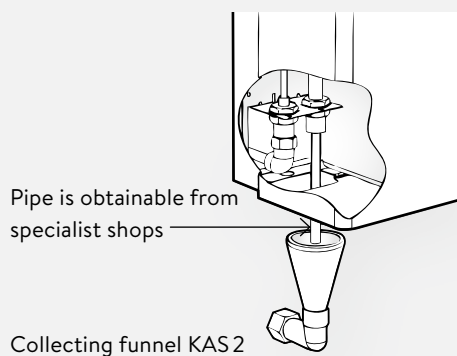

Surface mounting with tube

In this case, a $\frac{1}{2}$ -inch screw connection is used to connect a pipe ($\varnothing = \text{min. } 12 \text{ mm}$) to the safety overflow. Its other end leads to the drainage of the sink in a visible place protected from scalding.

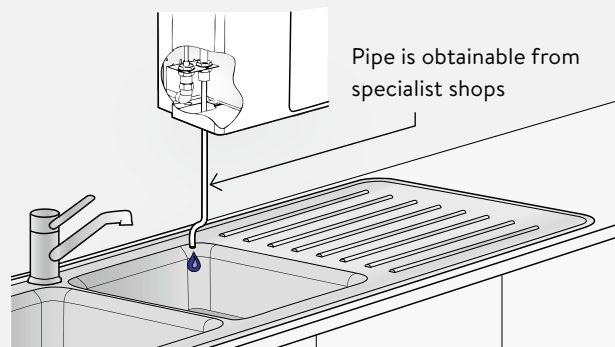

Boiling water heater KA Accessories

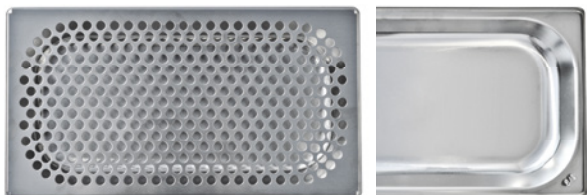

KAT1 (optional)
Stainless steel-tableau, 32.5 × 17.5 cm
KAT1: Part no. 4100-44080



KAT2 (optional)
Stainless steel-tableau with drain connection,
32.5 × 17.5 cm
KAT2: Part no. 4100-44081



KAS1 (optional)
Collecting funnel for undersink installation, 3/4-inch
KAS1: Part no. 4100-44085



KAS2 (optional)
Collecting funnel for wall installation, 3/4-inch
KAS2: Part no. 4100-44086

Boiling water heater KA Accessories

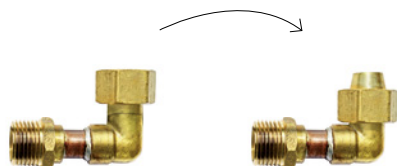

KAW (optional)

Connection angle for flush installation
½-inch to ½-inch union nut

KAW: Part no. 4100-44087



KA AZ (optional)

Connection set for 1 or 2 additional
side dispensing valves for KA15 and KA25

KA AZ: Part no. 84426



KA A (optional)

Connection set for 1 or 2 additional
side dispensing valves for KA40

KA A: Part no. 84427

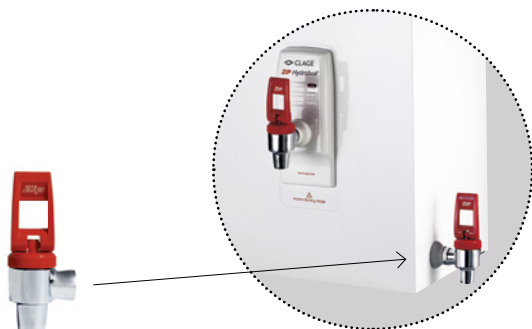

KA Z (optional)

Additional dispensing valve for KA15..40

KA Z: Part no. 84321



Filter system CLARIS ULTRA for water softening (optional)

For hard, chalky water, the filter system CLARIS ULTRA is to be used (recommended from 10 °KH).

Filter head suitable for all CLARIS ULTRA-filter

Filter head Universal: Part no. 84519

Filter cartridge, capacity at 10 °KH 4.200 litre

CLARIS ULTRA 500: Part no. 84500

Filter cartridge, capacity at 10 °KH 8.500 litre

CLARIS ULTRA 1000: Part no. 84501

Filter cartridge, capacity at 10 °KH 20.000 litre

CLARIS ULTRA 2000: Part no. 84502